

LCP-3215

***1.5 Amp, 10 Watt
Temperature Controller
for Thermoelectrics***

INSTRUCTION MANUAL

TABLE OF CONTENTS







Features	2
Safety Summary	3
Front Panel At a Glance	4
Rear Panel At a Glance	5
Preparing the Temperature Controller for Use	5
Operation Guide	6
Configure the PI Constants	6
Analog Input & Output	7
General & Electrical Specifications	7
Mechanical Specifications	7
Cable Accessories	8
Warranty	8

FEATURES

Key Features . . .

- Stabilities to $< 0.005^{\circ}\text{C}$ - *Even at ambient*
- Interfaces with Thermistor Temperature Sensors
- Compact model delivers 10 Watts
- Wide temp. range from -99°C to $>+150^{\circ}\text{C}$
- Easy to adjust operating temperature and TE current limit
- Linear, low noise, bipolar current source
- Operates on standard AC voltages

. . . The Wavelength Advantage

-  PI Control Loop with "Smart Integrator" overshoot suppression
-  Proportional Gain Adjusts from 10 to 50
-  Integral Time Constant Adjusts from 1 - 10 sec.
-  Analog Input to adjust Setpoint remotely
-  Temperature Monitor Output
-  One Year Warranty

The LCP-3215's advanced design offers a combination of features, performance, and value. The LCP-3215 controls temperature using a wide variety of thermistor temperature sensors. Two thermistor bias currents ($10\mu\text{A}$ and $100\mu\text{A}$) can be conveniently selected from the front panel. Select the 3 ½ digit display to read either the desired thermistor setpoint resistance or the actual thermistor resistance. A precision 10-turn potentiometer adjusts the thermistor setpoint resistance. The actual thermistor resistance can also be remotely monitored via the 9 pin male D-Sub connector on the rear panel. Connect a D/A or any other analog voltage to the rear panel BNC connection and control the thermistor setpoint resistance remotely.





The fast PI control circuitry provides low noise, stable performance for even the most stringent temperature control situations. The ultra-stable, low-noise operation is provided by flexible analog Proportional / Integral control electronics with "Smart Integrator" overshoot suppression. With proportional gain adjustable from 10 to 50 and integral time constant adjustable from 1 to 10 seconds, the PI control loop can stabilize a large variety of thermal loads. Both the proportional gain and integral time constant trimpot adjustments are conveniently located on the LCP-3215's front panel.



The TE Current Limit protects the thermoelectric module from being damaged. An easy to access front panel trimpot adjusts the current limit from 0 to 1.6 Amps. When the LCP-3215 is in current limit, a red LED indicates this condition on the front panel.

Safety Summary

Do not install substitute parts or perform any unauthorized modification to the product. Return the product to Wavelength Electronics for service and repair to insure that safety features are maintained.

Do not use this product beyond its specifications.

SYMBOL	DEFINITION OF SYMBOL
	<p>WARNING Calls attention to a procedure, practice, or condition that could possibly cause bodily injury or death.</p> <p>ATTENTION Ce symbole signale une procédure ou des conditions dangereuses pouvant entraîner des blessures corporelles ou la mort.</p> <p>VORSICHT! Nichtbeachtung der Hinweise können die körperliche Unversehrtheit beeinträchtigen oder zum Tod führen.</p>
NOTE!	<p>Calls attention to a procedure, practice, or condition that could possibly cause damage to equipment or devices being operated by this equipment.</p>
	<p>CAUTION Risk of Electric Shock ATTENTION Risque d'Electrocution VORSICHT Hochspannung</p>
	<p>Earth Ground Symbol</p>
	<p>Chassis Ground Symbol</p>

NOTE!	<p>Complete all operational steps in the order provided. Skipping a step can result in damage to the device being controlled or the Thermoelectric Module. Start with the section appropriate to the type of sensor you are using</p>
	<p>WARNING For continued protection against fire, replace line fuse only with fuse specified, type and rating.</p> <p>ATTENTION Pour une protection permanente contre les risques d'incendie, ne remplacer les fusibles secteur que par des fusibles conformes aux spécifications.</p> <p>VORSICHT Defekte Sicherungen sind nur durch die angegeben Typen und mit den spezifizierten Werten zu ersetzen um die Sicherheit des Gerätes zu gewährleisten.</p>
	<p>CAUTION RISK OF ELECTRICAL SHOCK. Do not power on this instrument if the case is damaged or any of the covers or panels are removed. NO USER SERVICEABLE PARTS INSIDE.</p> <p>ATTENTION Risque d'Electrocution. Ne pas mettre sous tension cet instrument si le boîtier est endommagé ou si les capots ou les faces sont retirés. Aucun composant réparable par l'utilisateur.</p> <p>VORSICHT Hochspannung. Im Falle eines Gerätedefektes oder bei geöffneter Verkleidung Netzstecker ziehen! Gerät kann und braucht vom Anwender nicht gewartet werden.</p>
	<p>CAUTION POSSIBLE ELECTRICAL SHOCK OR FIRE HAZARD. Do not expose the LCP Temperature Controller to rain or moisture. Do not operate this instrument in the presence of flammable gases or fumes.</p> <p>ATTENTION Risque d'electrocution ou d'incendie. Ne pas exposer l'alimentation LCP à la pluie ou à l'humidité. Ne pas utiliser cet instrument en présence de gaz inflammable ou de fumée.</p> <p>VORSICHT Brandgefahr und Gefahr eines elektrischen Schocks! Setzen Sie das Gerät nicht dem Regen oder der Feuchtigkeit aus. Schalten Sie das Gerät in der Gegenwart entflammbarer Gase oder Dämpfe nicht ein!</p>

Front Panel At A Glance

The following terms for the front panel components will be referenced throughout this manual.

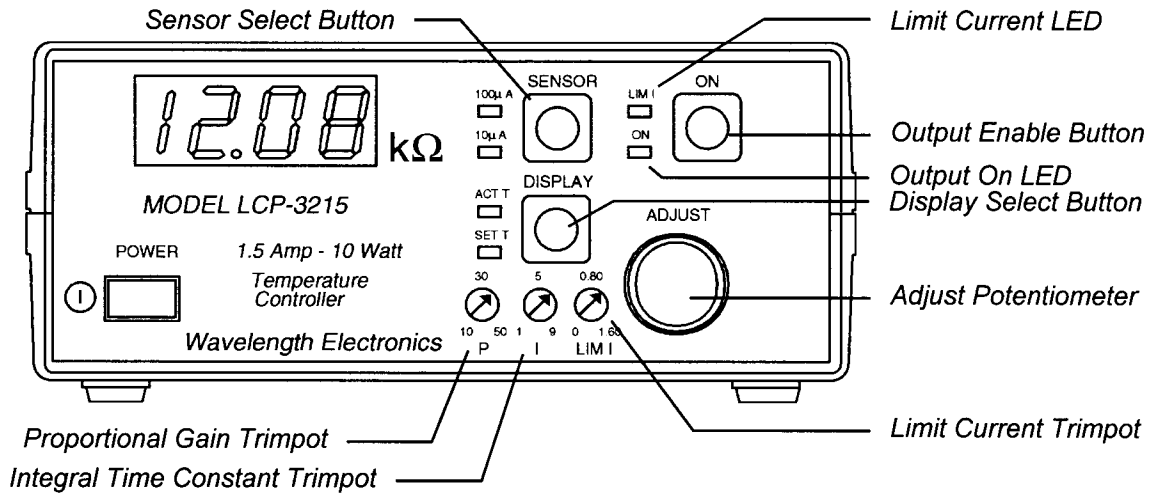

Output Section:

Output Enable Button: This button enables and disables the thermoelectric current source output. When the output is enabled, the current is determined by the load conditions. If the output is disabled, the output current is brought to a very low standby current.

Output On LED: This LED lights green whenever the output is enabled and current flows through the TE module.

Limit Current LED: This LED lights red whenever the output thermoelectric current is limited to the adjustment set by the Limit Current Trimpot. This condition will remain until the current required to achieve temperature falls below the Limit Current Trimpot setting. This condition does not create an error to shut the output off.

Adjust Potentiometer: This ten-turn linear potentiometer is used to adjust the Thermistor Resistance Setpoint.

Sensor Section:

Sensor Select Button: This button sets the thermistor sensor bias current to either 10 μ A or 100 μ A. A thermistor bias current of 10 μ A is optimum for thermistors whose values are between 20 k Ω and 200 k Ω . A thermistor bias current of 100 μ A works with thermistors whose values are between 0 k Ω and 20 k Ω . The display resolution in the 100 μ A range is 10 Ω . The display resolution is 100 Ω in the 10 μ A range. The output will be disabled any time the Sensor Select Button is pressed.

100 μ A LED: This LED lights green when the sensor bias current is 100 μ A .

10 μ A LED: This LED lights green when the sensor bias current is 10 μ A .

Display Section:

3 1/2 Digit Display: This displays the actual thermistor resistance or the thermistor setpoint resistance.

Display Select Button: This button selects between displaying actual thermistor resistance or thermistor setpoint resistance.

ACT T LED: This LED lights green whenever the actual thermistor resistance is displayed.

SET T LED: This LED lights green whenever the thermistor setpoint resistance is displayed.

Trimpot Adjust Section:

Proportional Gain Trimpot: This single turn trimpot adjusts the proportional gain for the PI control loop. Turning the trimpot adjust clockwise increases proportional gain from 10 to 50. The numbers surrounding the trimpot are approximations and should be used as reference points when setting the proportional gain. The arrow on the trimpot indicates the setting. When adjusting the proportional gain, it is recommended to disable the output momentarily to reset the Integrator.

Integral Time Constant Trimpot: This single turn trimpot adjusts the integral time constant for the PI control loop. Turning the trimpot adjust clockwise increases the integral time constant from 1 to 10 seconds. The numbers surrounding the trimpot are approximations and should be used as reference points when setting the integral time constant. The arrow on the trimpot indicates the setting. After adjusting the integral time constant, disable the output momentarily to reset the Integrator.

Limit Current Trimpot: This single turn trimpot adjusts the maximum output current. The LIMIT I should be set below the maximum current of your thermoelectric (I_{MAX}). Turning the trimpot clockwise increases the maximum output current from 0 to 1.6 Amps. The numbers surrounding the trimpot are approximations and should be used as reference points when setting the limit current. The arrow on the trimpot indicates the setting.

Rear Panel At A Glance

The following terms for the rear panel components will be referenced throughout this manual.

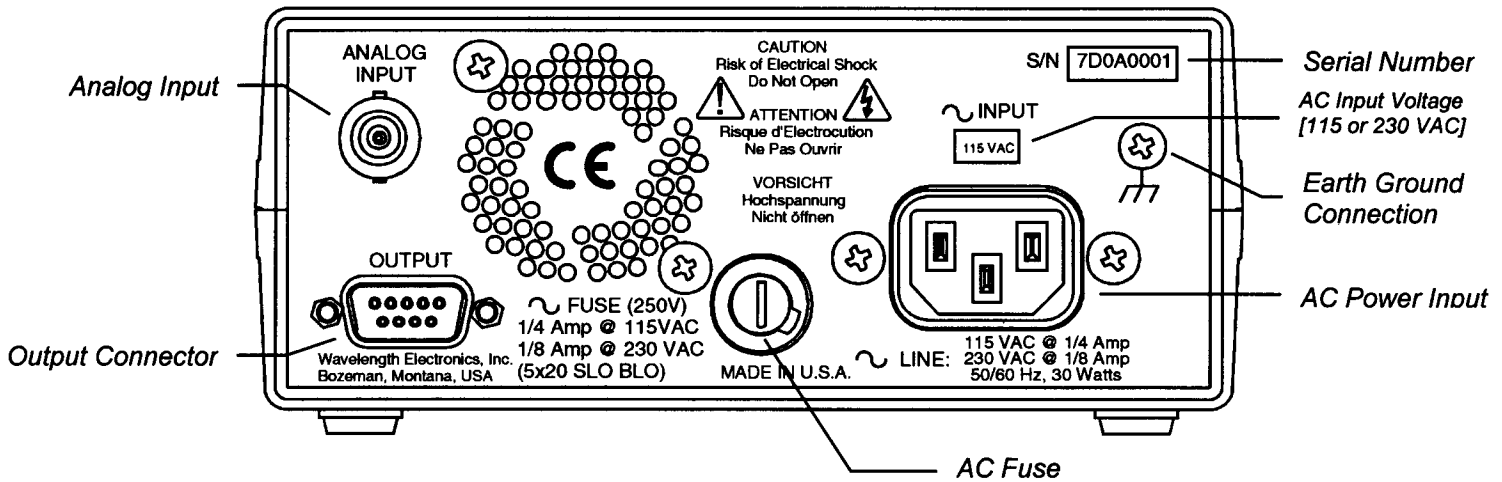

Output Connector Description

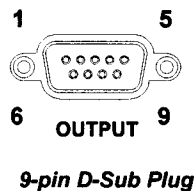

Pins 1 & 2: (TEC+, TEC-) These pins supply current to the TE Cooler.

Pins 4 & 5: (Sens-, Sens+) These pins source 10 or 100 μ A current to bias thermistor temperature sensors.

Pins 7 & 8: (ACT T, Signal Ground) Monitor the actual thermistor resistance remotely.

Pin 3, 6, & 9: (Signal Ground) This pin connects directly to control electronics ground.

Preparing the Temperature Controller for Use

Check the list of supplied items:

- One Power cord
- One 9 pin D-Sub receptacle (solder cup), hood, and connecting hardware
- One AC Fuse installed
- One 50 Ω terminator
- One AC Fuse is shipped separately.
- This User's Guide

NOTE! Verify the correct power line voltage is displayed on the AC Power Indicator.

The factory sets the following defaults based on the country of destination for initial shipment:

Destination	Voltage Setting	Fuse Rating
US, Canada	115V	1/4 A
UK	230V	1/8 A
Continental Europe	230V	1/8 A
Japan	115V	1/4 A

For operation between 100 and 120VAC, install a 1/4 Amp slo-blow 5 x 20 mm fuse.

For operation between 220 and 240VAC, install a 1/8 Amp slo-blow 5 x 20 mm fuse.

Operation Guide

NOTE!

Do not enable the output current until the limit is properly set!

Step 1: Cabling the Output Connector

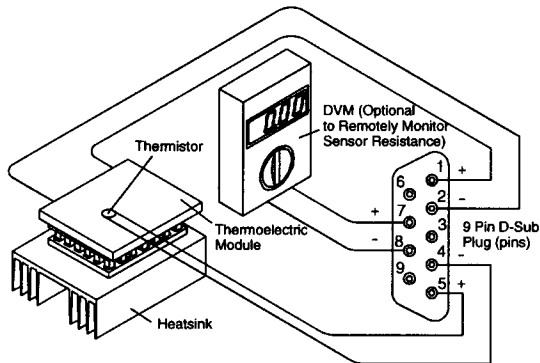

9 pin D-Sub receptacle	
Pin 1:	TEC+
Pin 2:	TEC-
Pin 3:	Signal Ground
Pin 4:	Sens -
Pin 5:	Sens+
Pin 6:	Signal Ground
Pin 7:	ACT T Monitor
Pin 8:	Signal Ground
Pin 9:	Signal Ground

Step 2: Adjust the LIMIT Current

Determine the maximum current through the thermoelectric module from specifications provided by the thermoelectric manufacturer. Setting the current limit just above the steady state current level may result in long settling times. If you set the limit at or above the maximum thermoelectric current, the power dissipated in the TE may overheat the load being controlled.

Use a small flat blade screwdriver to rotate the Limit Current Trimpot to the proper setting.

Step 3: Select the proper thermistor Current

Based on your control temperature range and thermistor value, select a thermistor bias current using the Sensor Select Button on the front panel. Use the 100 μ A thermistor bias current for thermistor values between 0 Ω and 20 k Ω . Use the 10 μ A bias current for thermistors ranging from 20 k Ω to 200 k Ω .

Step 4: Select the PI Constants

The most common PI settings for thermistors are:

P - Gain = 30

I - Integral Time Constant

= 1 to 3 second for small loads (< 1" x 1" x 1")

> 5 seconds for large loads (> 1" x 1" x 1")

Step 5: Adjust the Temperature Setpoint

Using the Display Select Button, select the thermistor setpoint resistance display (SET T). Rotate the Adjust Potentiometer to the value of thermistor resistance that corresponds to the desired operating temperature.

Once the thermistor setpoint resistance has been adjusted, press the Display Select Button to display the thermistor actual resistance (ACT T).

Step 6: Enable the Output Current

Press and release the Output Enable Button. The Output On LED will light green. For a small load, the LIM I LED will briefly light red. More current is required to initially change the load temperature than to maintain it once it is cool.

Configure the PI Constants

The proportional gain and integral time constant can be selected to minimize temperature overshoot, reduce settling time, and improve temperature stability.

NOTE! After adjusting either the P or I term, disable the output to reset the system and evaluate the effect of the change(s).

Proportional Gain Adjustment: The proportional gain can be adjusted from 10 to 50 using the front panel *P Trimpot*. For most applications, a proportional gain between 25 and 35 provides the best results. A gain of 30 is optimum for small loads such as laser diodes or optical detectors.

When your thermal load is unknown, start with a gain of 30 and an integrator time constant of 1 second. Enable the output and allow the actual thermistor resistance to settle around the thermistor setpoint resistance. If the thermal load cycles or appears unstable, reduce the proportional gain until the cycling stops. If the temperature does not stabilize, then adjust the proportional gain to 30 and increase the integrator time constant.

Integrator Time Constant Adjustment: The integrator time constant can be adjusted from 1 to 10 using the front panel *I Trimpot*. For most applications, an integrator time constant between 1 and 3 seconds provides the best results. An integrator time constant of 1 second is optimum for small loads such as laser diodes or optical detectors.

Begin with an integrator time constant of 1 second. Enable the output and observe the temperature stability once the temperature settles around the thermistor setpoint resistance. If the thermal load cycles or appears unstable, increase the integrator time constant until cycling stops.

Analog Input and Output

Analog Input BNC: An external analog signal can be directly connected to the Analog Input BNC to remotely control the temperature setpoint. This input is configured to accept ± 2 V signals while withstanding inputs as large as ± 10 V. Any input on these pins is directly summed with the thermistor resistance setpoint determined by the Adjust Potentiometer. The impedance of this input is 1 M Ω as measured across the BNC connector. The Analog Input has the following transfer function depending on the bias current selected:

Bias Current	Conversions
100 μ A	10 k Ω / V
10 μ A	100 k Ω / V

NOTE!

The shield side of the Analog BNC input is chassis grounded.

If the ANALOG INPUT is not used, install the 50 Ω terminator (provided with the unit) on the BNC input.

Output Connector Pins 7 & 8: (ACT T Monitor, Monitor Common) Pin 7 provides a buffered measurement of the sensor voltage measured across pins 4 and 5 of the Output Connector and is referenced to pin 8. Its transfer function is dependent on sensor choice and is given in the following table. This output is internally limited to 2 mA maximum output current. This output can be used to measure thermistor resistances that exceed the display range of 0 to 19.99 k Ω on the 100 μ A setting or 0 to 199.9 k Ω on the 10 μ A setting. The ACT T monitor will measure a maximum of 50 k Ω (100 μ A) or 500 k Ω (10 μ A) from this output with a voltmeter.

To convert the ACT T Monitor to thermistor resistance, use the following transfer functions:

Bias Current	Conversions
100 μ A	10 k Ω / V
10 μ A	100 k Ω / V

General Specifications

Power Supply:

115 VAC $\pm 15\%$ @ $\frac{1}{4}$ Amp
230 VAC $\pm 15\%$ @ $\frac{1}{8}$ Amp
50 or 60 Hz

Maximum AC Input:

250 VAC

Power Consumption:

30 Watts Maximum

Size (W x D x H)

63.5 mm x 154.4 mm x 158.8 mm
(2.5" x 6.08" x 6.25")

Weight

1.6 kg (3.5 lb.)

Operating Temperature:

0 to +40°C

Storage Environment:

- 40 to +70°C

EMI and Safety:

CE Compliant

ELECTRICAL SPECIFICATIONS

Temperature Control

Temp. Control Range ①	-99 to +150°C
Short Term Stability, 1 hr. ②	< 0.005°C
Long Term Stability, 24 hrs. ②	< 0.008°C

TEC Output

Bipolar Output Current	± 1600 mA
Compliance Voltage	± 7 V
Maximum Output Power	10 W
Current Limit Range	0 to ± 1600 mA
Control Loop	PI
Proportional Gain, adjustable	10 to 50
Integrator time constant, fixed	1 to 10 seconds

Temperature Sensors

Thermistor Types (2 wire)	NTC
Thermistor Sensing Current	10 μ A & 100 μ A
Thermistor Range	0 Ω - 500 k Ω

Display Resolution

Resistance 100 μ A sensor current	0 - 19.99 k Ω
10 μ A sensor current	0 - 199.9 k Ω

① Temperature Range depends on the physical load, sensor type, sensor current, and TE module used.

② Stability quoted for a typical 10 k Ω thermistor at 100 μ A sensing current.

MECHANICAL SPECIFICATIONS

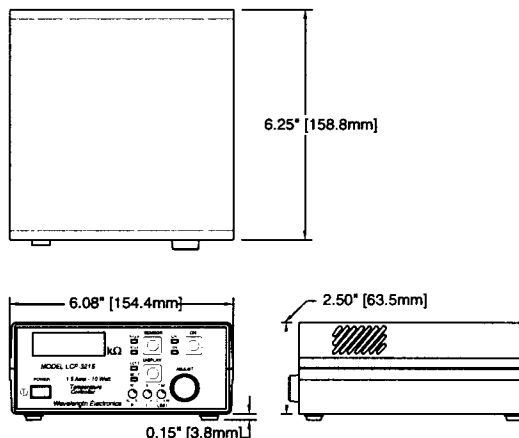

ORDERING INFORMATION

Model	Description
LCP-3215	10 W, 1.5 Amp, 7 Volt, Temperature Controller

Each LCP-3215 includes: One 9 pin D-sub receptacle with shielded covers and hardware, user guide, and AC power cord.

OPTIONAL CABLE ACCESSORIES

Cable - Selection Guide

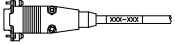
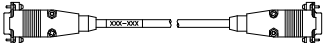
Model	Description
 CAT-206	Output cable, single connector (9 pin D-sub rec) One end connectorized one end unterminated
 CAT-207	Output cable, double connector (9 pin D-sub rec's) Both ends connectorized

All cables are 1 meter long.

PIN	WIRE COLOR	TERMINATION
1	RED	TEC+
2	BLACK	TEC-
3	BROWN	Signal Ground (not used)
4	GREEN	SENS-
5	WHITE	SENS+
6	ORANGE	Signal Ground (not used)
7	YELLOW	Actual Temperature
8	BLUE	Signal Ground
9	SHIELD	Signal Ground

Thermistor Selection Guide (Optional)

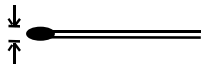
Body Dia: .060 to .095"		3" long leads - Teflon insulated solid nickel - AWG 30	
MODEL	R @ 25°C	10 μ A RANGE	100 μ A RANGE
TCS-602	2.252 k Ω	-60°C to -12°C	-33°C to +15°C
TCS-605	5 k Ω	-55°C to -2°C	-20°C to +33°C
TCS-610	10 k Ω	-45°C to +13°C	-8°C to +50°C
TCS-620	20 k Ω	-35°C to +28°C	+6°C to +69°C
TCS-650	50 k Ω	-18°C to +49°C	+25°C to +92°C
TCS-651	100 k Ω	-6°C to +67°C	+41°C to +114°C

WARRANTY

If you have any questions or comments, please call our technical staff at (406) 587-4910. Our hours are 8:00 a.m. to 5:00 p.m. MT.

Wavelength warrants the LCP-3215 temperature controllers for one year against defects in materials and workmanship when used within published specifications. This warranty extends only to purchaser and not to users of purchaser's product. If Wavelength receives written notice of such defects during the warranty period, we will either repair or replace products which prove to be defective. It is purchaser's responsibility to determine the suitability of the products ordered for its own use. Wavelength makes no warranty concerning the fitness or suitability of its products for a particular use or purpose; therefore, purchaser should thoroughly test any product and independently conclude its satisfactory performance in purchaser's application. No other warranty exists either expressed or implied, and consequential damages are specifically excluded. The remedies provided herein are the Buyer's sole and exclusive remedies.

All products returned must be accompanied by a Return Material Authorization (RMA) number obtained from the Customer Service Department. Returned product will not be accepted for credit or replacement without our permission. Transportation charges or postage must be prepaid. All returned products must show invoice number and date and reason for return. No user serviceable parts inside. Refer servicing to service-trained personnel.

The information contained within this document is subject to change without notice. Wavelength Electronics makes no warranty of any kind with regard to this material, including, but not limited to, the implied warranties of merchantability and fitness for a particular purpose. No part of this document may be photocopied, reproduced, or translated to another language without the prior written consent of Wavelength Electronics.

PHONE (406) 587-4910 FAX (406) 587-4911
email: wavelength@imt.net
WEB: wavelengthelectronics.com
P O BOX 865, BOZEMAN, MT 59771